



CCIE Lab Center

CLC - CCIE Security v6: Real Lab1 - Design

CLC

Website
<https://ccielabcenter.com>

Forum
<https://forum.ccielabcenter.com>

CCIE Security
Real Lab1: Module1

<https://t.me/learningnets>

CCIE Lab Center

CLC

CCIE Security

Real Lab1: Design

The Trusted Name In CCIE

CCIE Lab Center

www.ccielabcenter.com

CCIE Enterprise Infrastructure	CCIE Security	CCIE DataCenter
CCIE Collaboration	CCIE Service Provider	CCIE Enterprise Wireless

Workbooks | Online Training | Rack rental | Proctor Lab | Virtual Simulator

The image shows a promotional graphic for CCIE Lab Center. It features a blue background with a circuit-like pattern on the left. At the top, it says 'The Trusted Name In CCIE' followed by 'CCIE Lab Center' and the website 'www.ccielabcenter.com'. Below this are six black buttons with white text, arranged in two rows of three. The first row contains 'CCIE Enterprise Infrastructure', 'CCIE Security', and 'CCIE DataCenter'. The second row contains 'CCIE Collaboration', 'CCIE Service Provider', and 'CCIE Enterprise Wireless'. At the bottom, there are five colorful arrow-shaped buttons pointing right: 'Workbooks' (orange), 'Online Training' (purple), 'Rack rental' (green), 'Proctor Lab' (pink), and 'Virtual Simulator' (blue). The entire graphic is reflected below it.

CCIE Lab Center

Workbook Description

Author: CCIE Lab Center (CLC)

Focus: Exam

Level: Expert (CCIE)

Stream: CCIE Security

Lab Version: Lab 1: Design

Document Revision: 1.2.0: Demo Version

Document Revision Date: December 06, 2022

Content: Topology, Question, Resources

Format: PDF

Protection: N/A

Website: <https://ccielabcenter.com>



[www.ccielabcenter.com](https://ccielabcenter.com)

World Best CCIE Certs

CCIE Lab Center

CCIE Security Lab1: Module1: Design

CLC CCIE Security v6.0: Lab 1.0: Design

DESIGN MAIN NETWORK TOPOLOGY

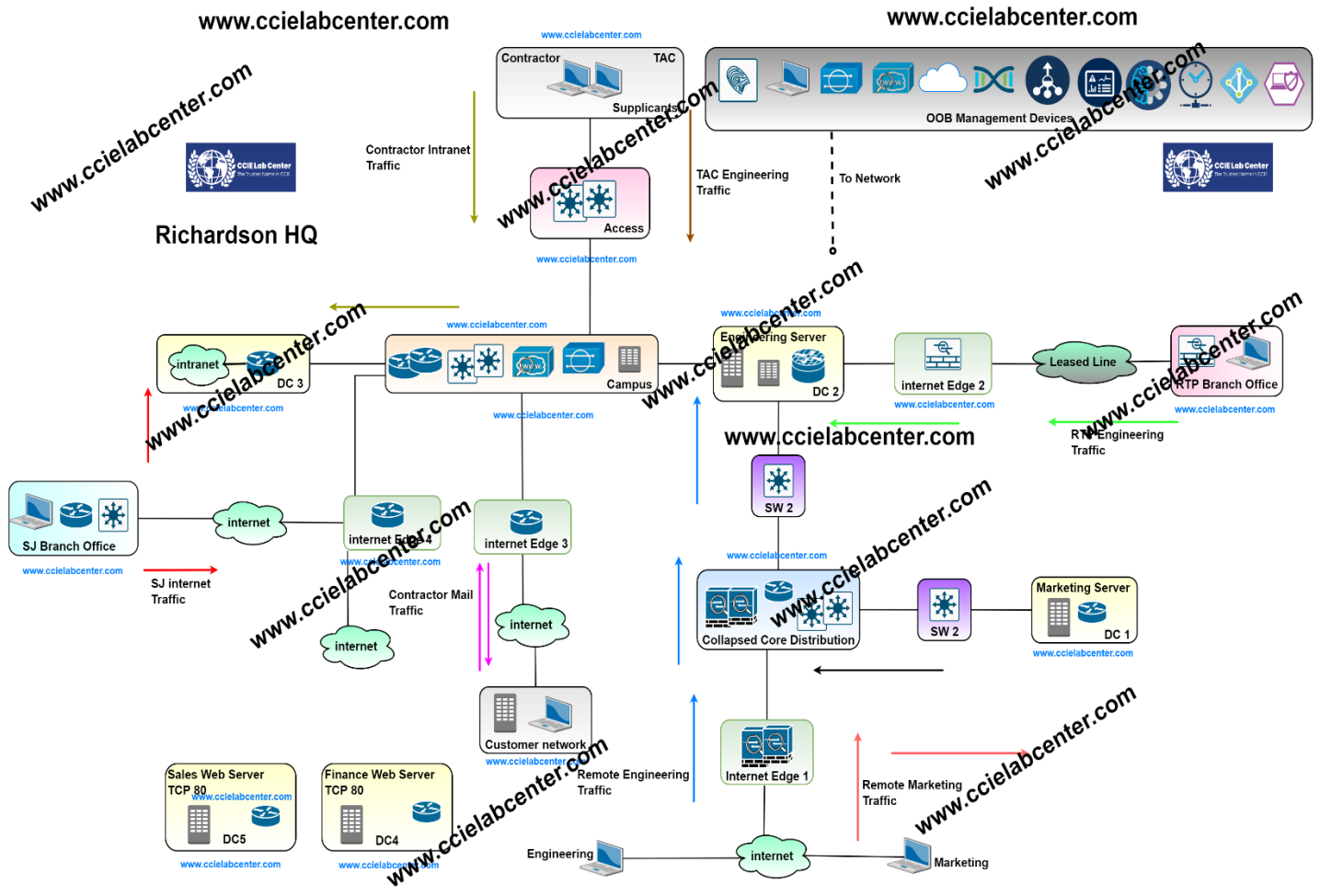

CCIE Lab Center

Design 1.2.0

1 of 34

Welcome!

Please read all the available resources before starting the scenario by clicking 'Next item'



www.ccielabcenter.com

World Best CCIE Certs

CCIE Lab Center

x of 34

Refer to the new resource(s) available.

Which four statements correctly represents Sales and Finance organization traffic flows? (Choose four).

- A. Sales and Finance traffic requires integrity but not confidentiality.
- B. Sales and Finance traffic requires confidentiality and integrity.
- C. DC5 is hosting Sales web services and DC4 is hosting Finance web services.
- D. Sales and Finance traffic requires confidentiality but not integrity.
- E. Sales traffic is destined for DC4 and Finance traffic is destined for DC5.
- F. The Sales and Finance web services are hosted on DC5.
- G. The Sales and Finance web services are hosted on DC4.
- H. Sales traffic is destined for DC4 and Finance traffic is destined for DC5.

<https://ccielabcenter.com>

Resource(s):-

Email: Design Recommendation

Mario: Based on the business requirements to protect the traffic flows, my recommendations are as follows for the remote access VPN solution:

1. Connections must be highly available
2. Any changes to the reachability of the servers must be dynamically learned and authenticated. That said, we need a static routing mechanism at the traffic tunnel terminal point.
3. Remote connection must allow access only to specific network services.
4. Traffic segmentation must be implemented for the traffic flows at HQ.
5. Remote users must be authenticated by a centralized identity source.
6. Access polices for remote users must be dynamic. --CoA.
7. Real address of web servers must be hidden from the outside access.
8. Network devices that are part of the design must use existing management domain for OOB access.
9. Network devices that are part of the design must by synchronized with existing network NTP source.
10. DNS protection must be incorporated in the design.
11. Traffic flow monitoring must be incorporated in the design for threat detection.
12. Threat mitigation must be incorporated in the design as part of rapid threat containment

Take a look at it and let me know if you have any question or concerns. I will set up a kickoff meeting with your operations team to formally start the project.

John: Thanks for the recommendations. They seem like a good starting point and will definitely server well to scope the future conversations. I will look for the meeting invite

CCIE Lab Center

x of 34

Which architecture represents the correct flow for the design?

Architecture 1

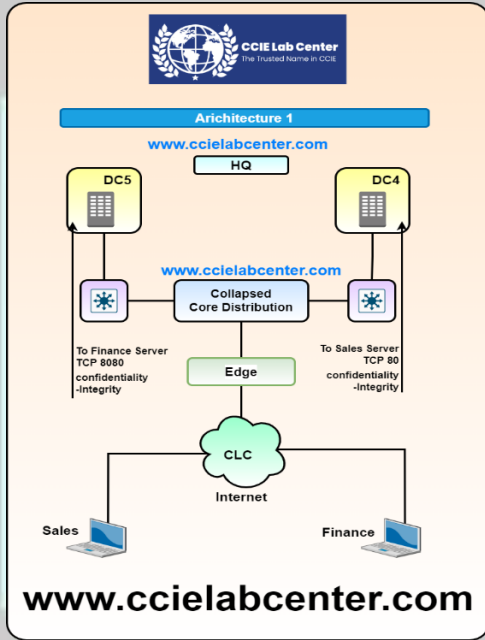

Architecture 2

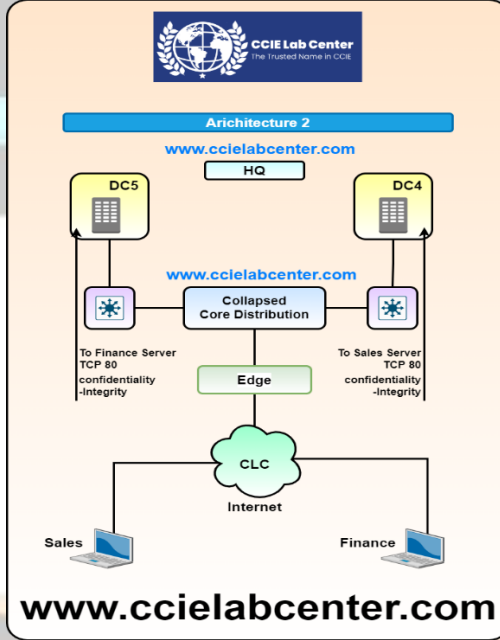

Architecture 3

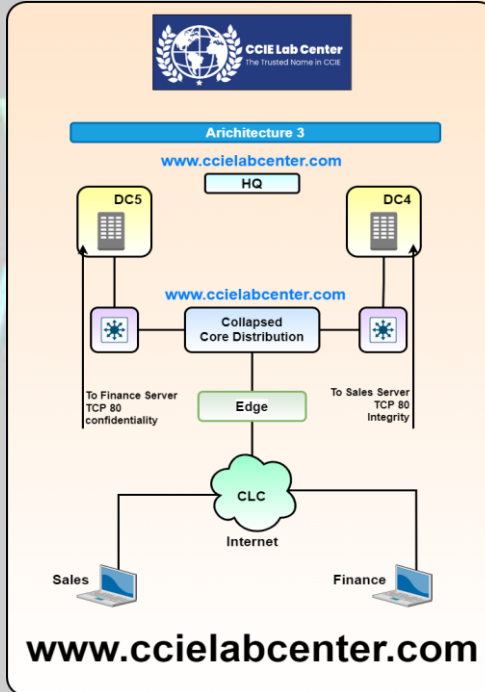

Architecture 4

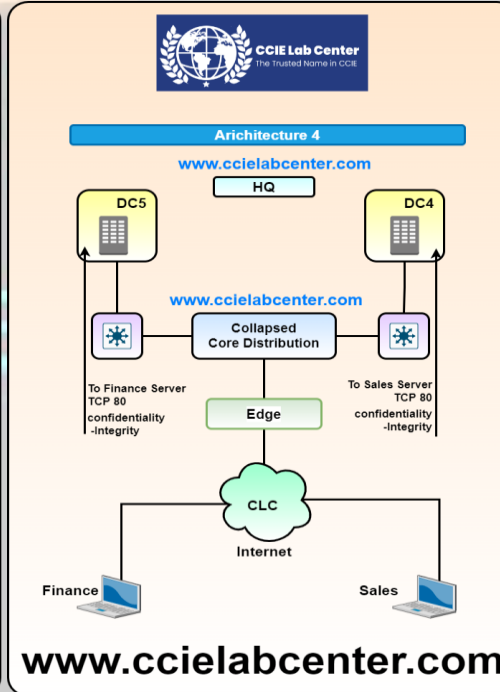

CCIE Lab Center

x of 34

Which type of flow and design functional control does the following show?

- A. External business flow that provides secure remote access with single point of failure
- B. External business flow that provides secure remote access with multiple points of failure
- C. Internal business flow that provides secure remote access with single point of failure
- D. Internal business flow that provides secure remote access with multiple points of failure
- E. Internal business flow that provides secure remote access with single point of failure
- F. External business flow that provides secure remote access with multiple points of failure
- G. External business flow that provides secure remote access with single point of failure
- H. Internal business flow that provides secure remote access with single point of failure

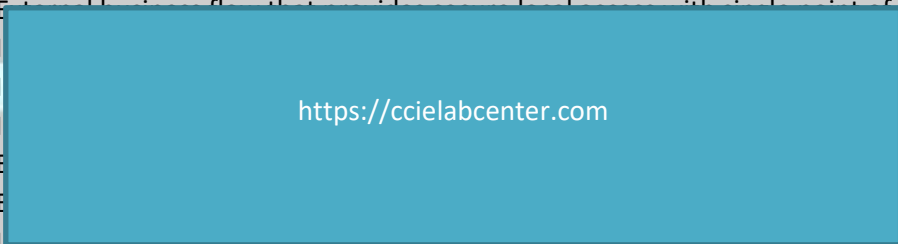

www.ccielabcenter.com
World Best CCIE Certs

CCIE Lab Center

x of 34

Refer to the new resource(s) available

Drag and drop the security capabilities from the left onto the corresponding attack surfaces on the right.

	NAS	HAS	DAS	AAS
Identity	Label 1	Label 1	Label 1	Label 1
Client-Based Security	Label 2		Label 2	Label 2

CCIE Lab Center

x of 34

Refer to the new resource(s) available.

Which config line correctly maps to its functionality in the ASA1v configuration provided to the customer?

Key cisco	It identifies to which group ISE belongs
aaa-server ccie protocol radius	ISE receives Sales and Finance session accounting updates every 60 minutes.
Inter	ISE as part of
aaa-se	face for ISE.
	4 characters.
a	el-group attributes.

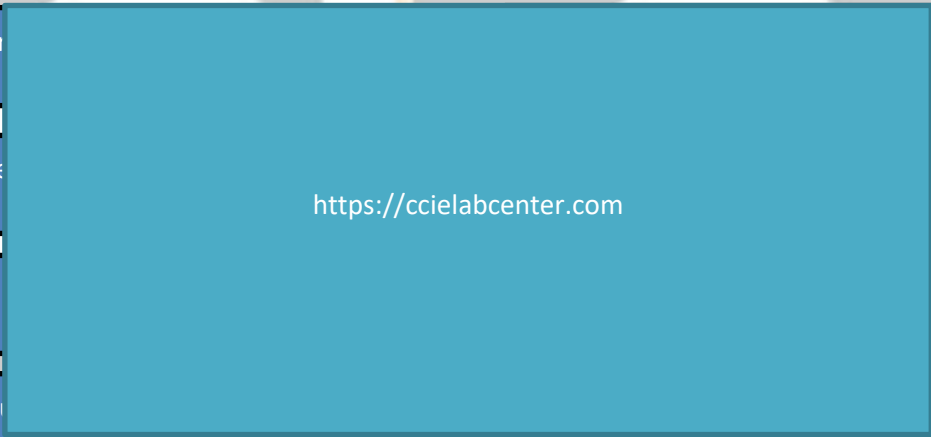

Resource(s)

Email: [Email Progress update 3](mailto:care@ccielabcenter.com)

John: Just so you know. We have completed the current phase of design. The new phase will be the last in which we will design, implement and validation technical consists of Identity management and information exchange components of the solution. I have attached the outcome of the current phase.

Let me know if you have any questions. I will keep you posted on the final phase.

Mario: Thanks for keeping us I the loop and sending the document. I am very pleased that we have made significant process and

CCIE Lab Center

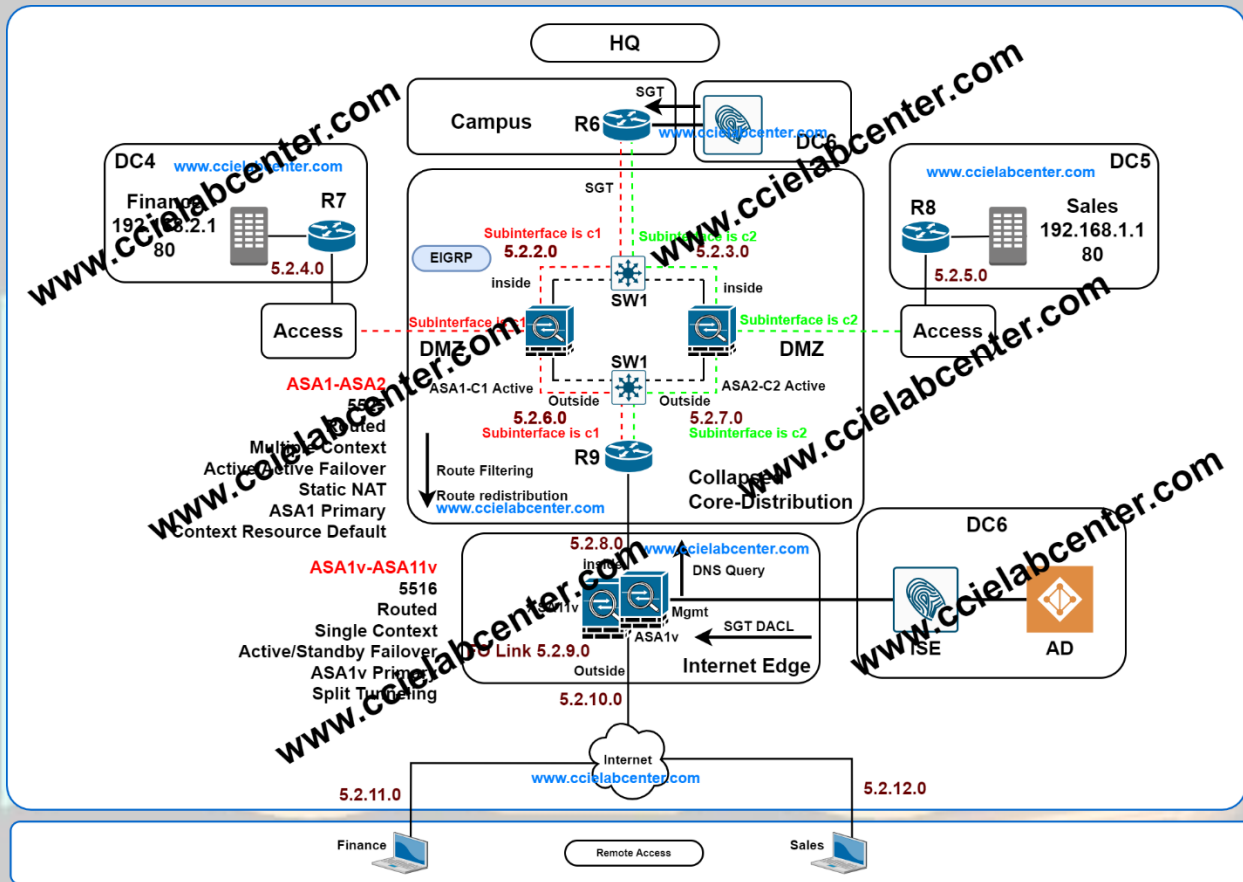

www.ccielabcenter.com
 World Best CCIE Certs

CCIE Lab Center

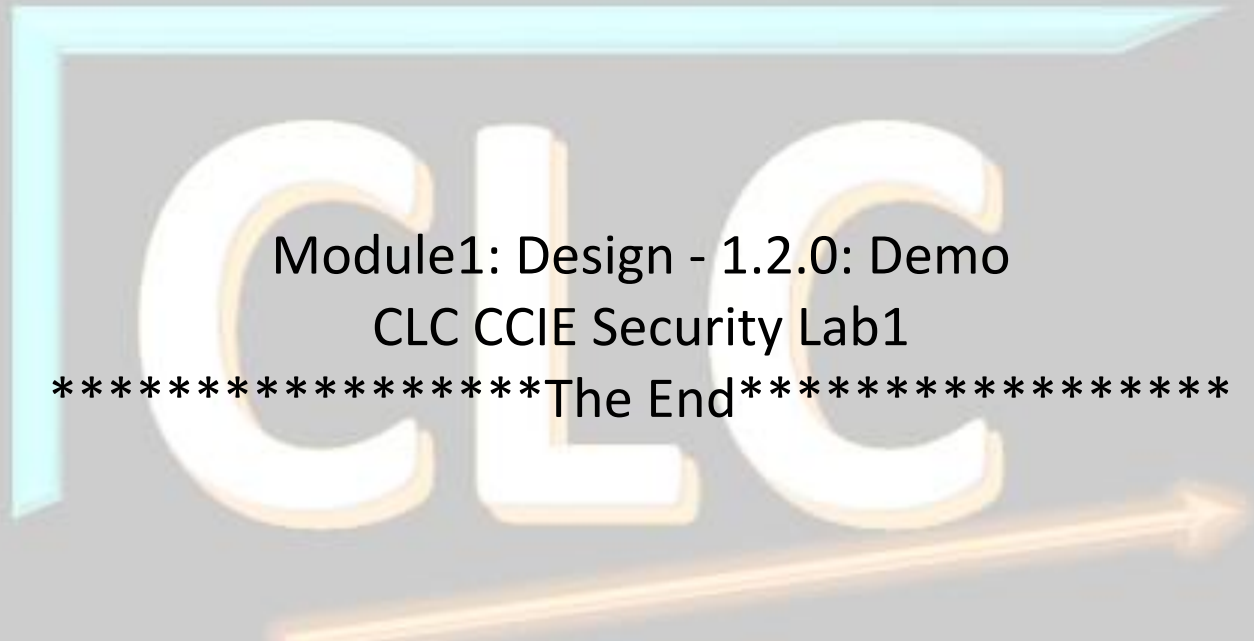

Module1: Design - 1.2.0: Demo
CLC CCIE Security Lab1

*****The End*****

100% Real | 100% Pass
Visit: www.ccielabcenter.com